

## Project ref. no.: PR-0036

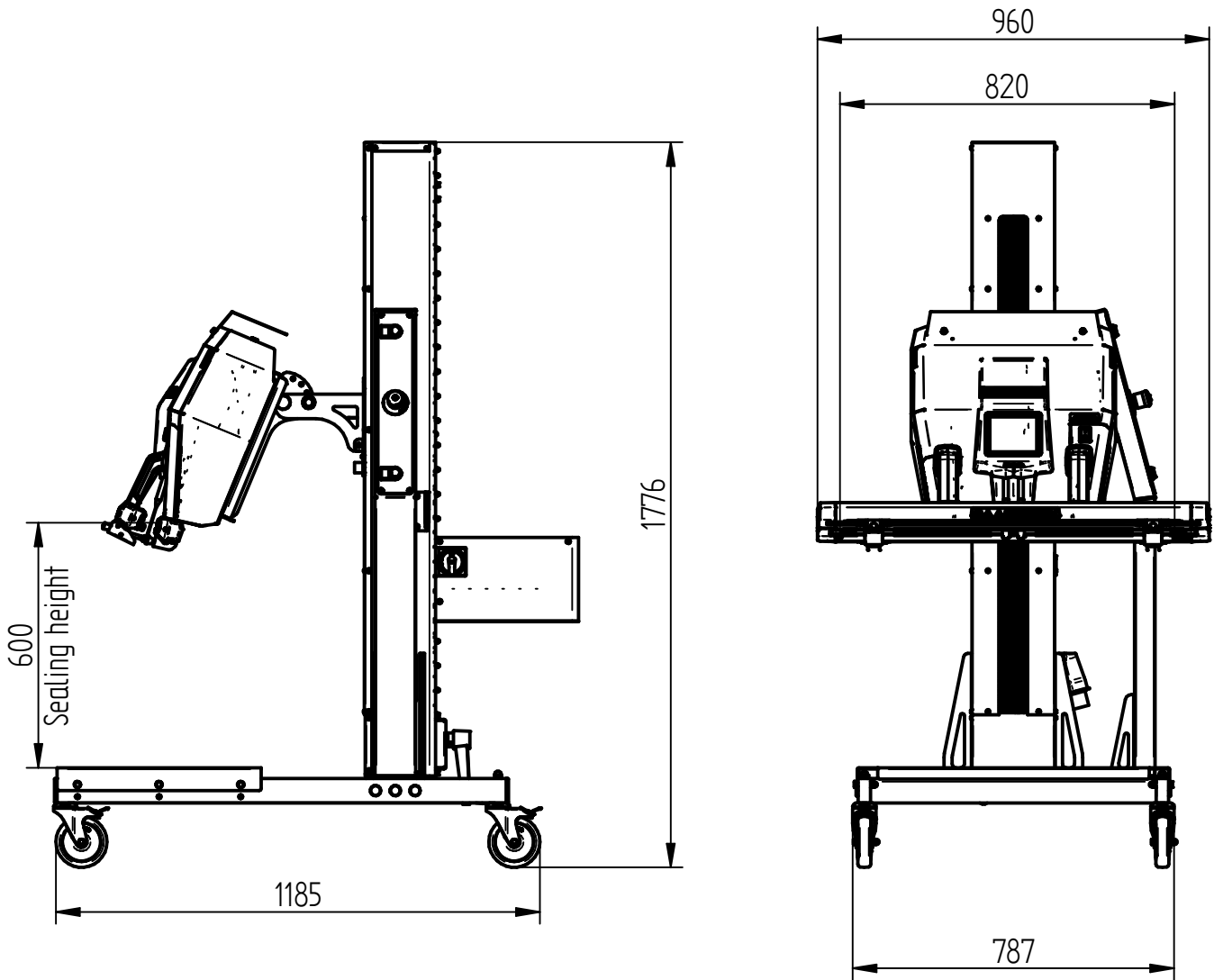



Sealing height (mm)	Tilted (45°)	Vertical	Horizontal
Min.	154	0	480
Max.	1161	926	1487