

## Project ref. no.: PR-0050

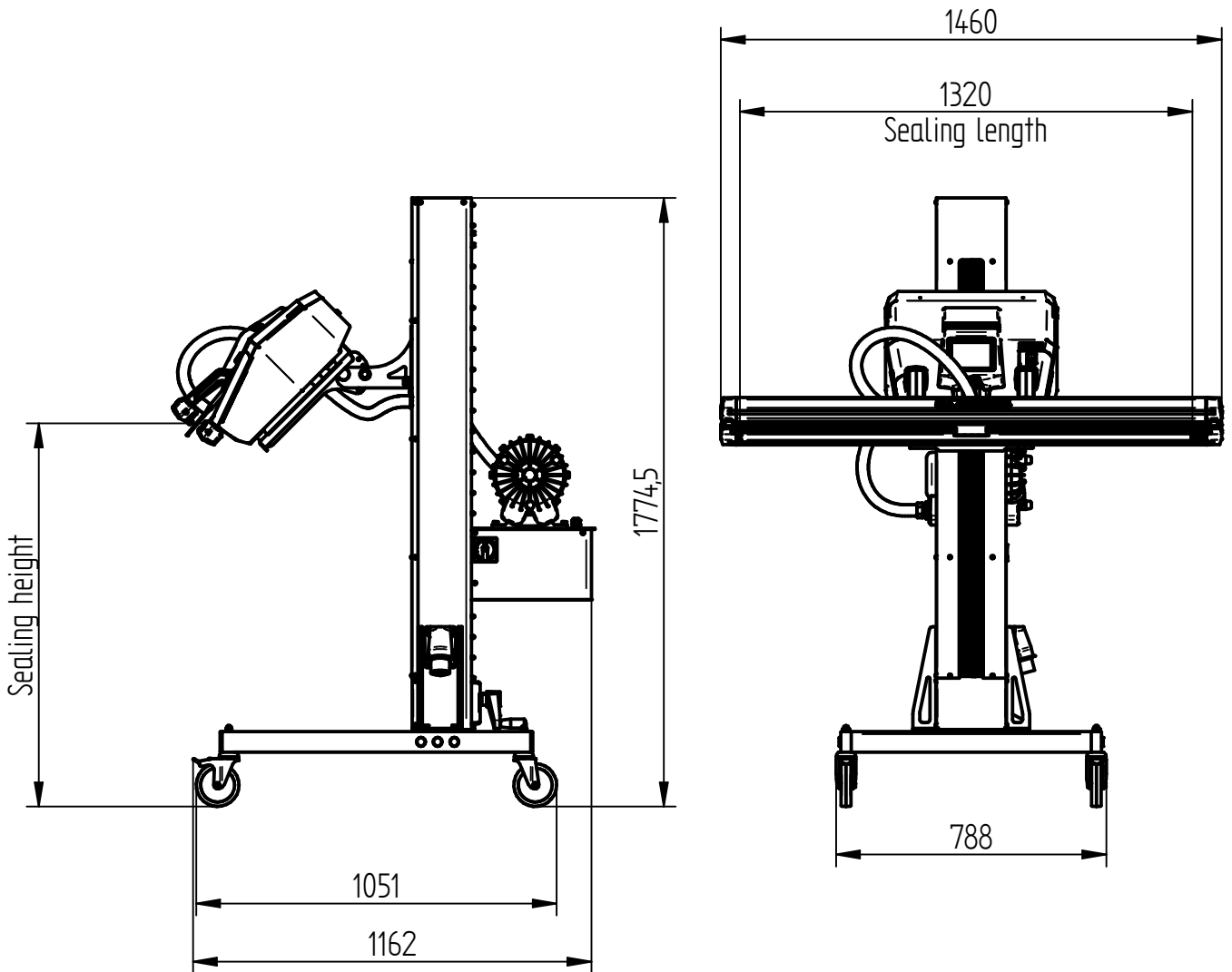



Sealing height (mm)	Tilted (45°)	Vertical	Horizontal
Min.	335	268	664
Max.	1335	1088	1664