

Project ref. no.: PR-0052

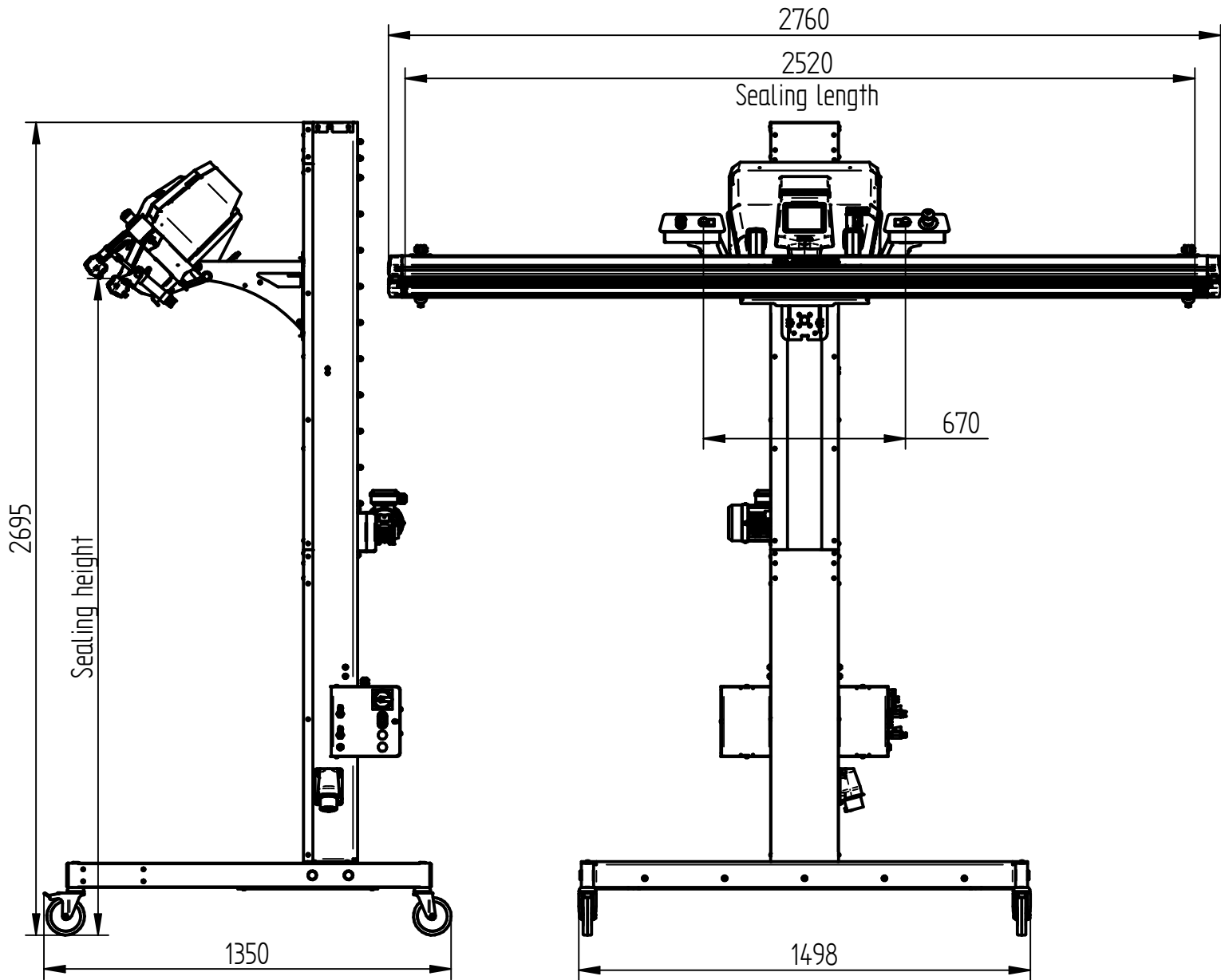



Sealing height (mm)	Tilted (45°)	Vertical	Horizontal
Min.	1470	1285	1675
Max.	2470	2285	2675