

## Project ref. no.: PR-0060

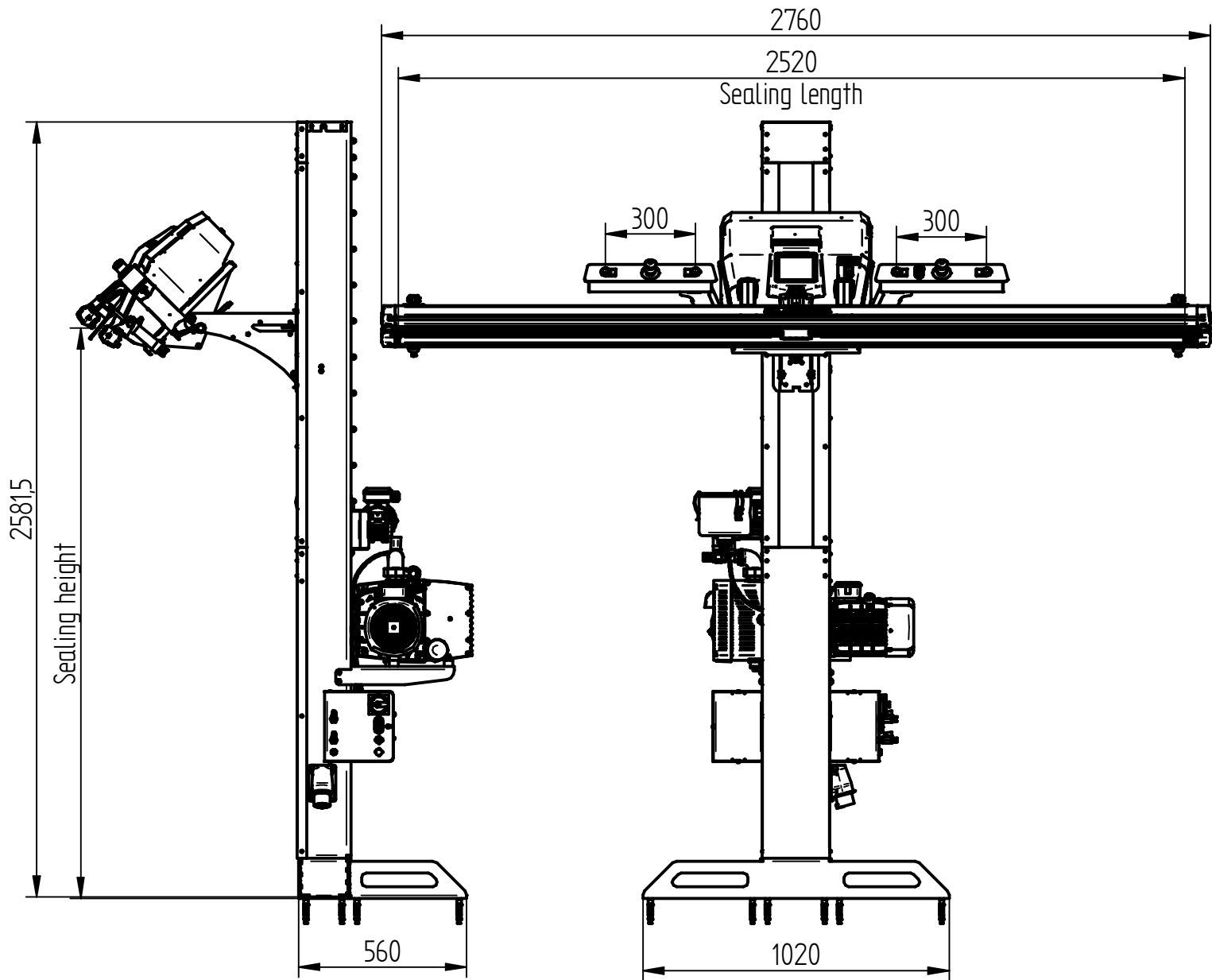



Sealing height (mm)	Tilted (45°)	Vertical	Horizontal
Min.	1370	1175	1575
Max.	2370	2175	2575