

Project ref. no.: PR-0061

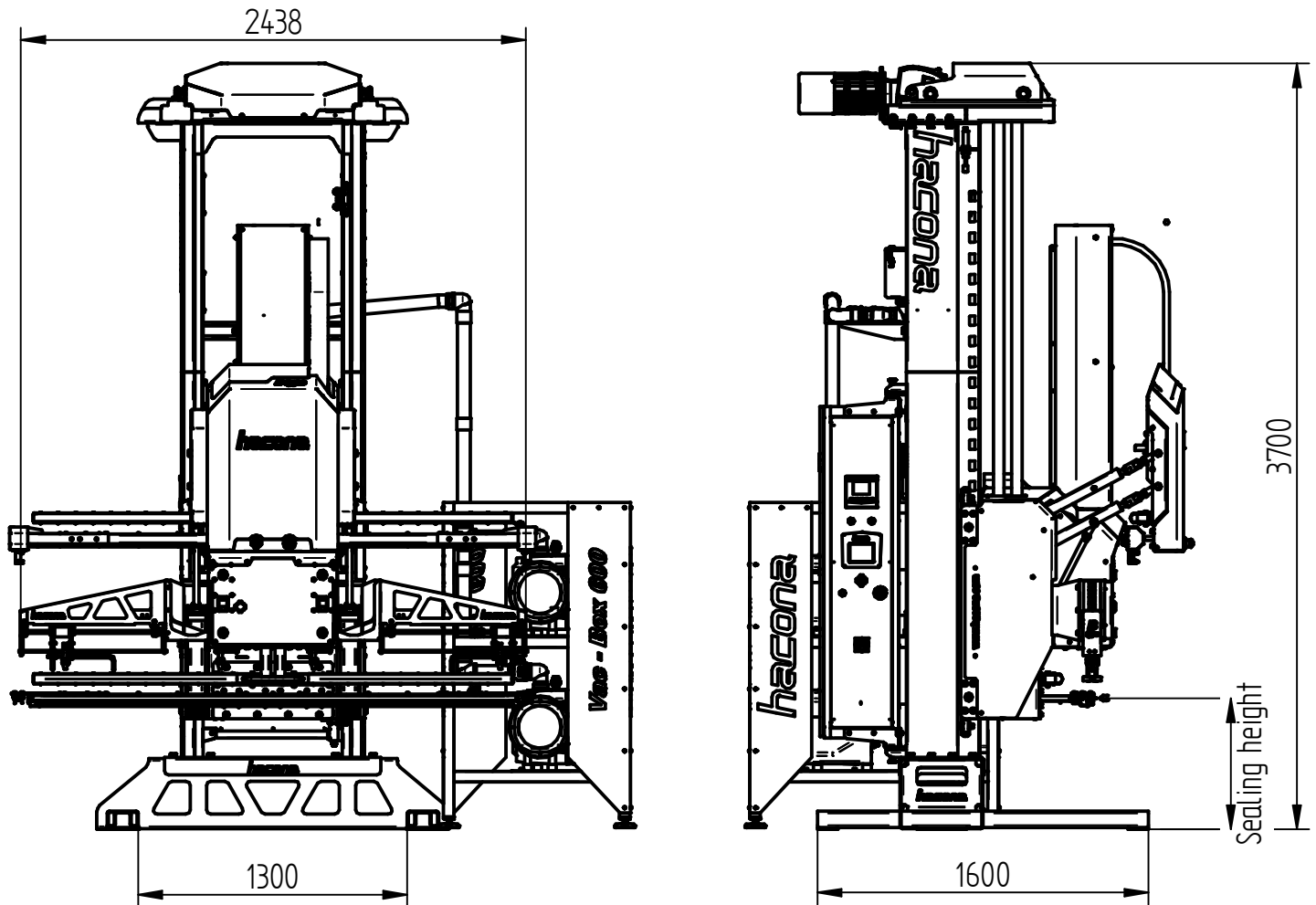



	Sealing height (mm)
Min.	671
Max.	2111

